

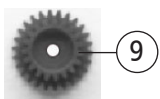

Pos. Nr. Pos.no.	Beschreibung Description	Art.-Nr. Art.no.	Preisgruppe Price bracket
706403	DB BR 064	=	N
706483		=	N
1	LOKGEHÄUSE KPL. Body assembly complete	10706403	034
2	LICHTLEITER-SATZ Light conductor set	00137086	011
3	HALTESTANGE Handrail	00197702	003
4	STEUERUNG KPL. MIT KUPPELSTANGE Reversing gear complete w. coupling rod	00327142	027
5	LOKFAHRGESTELL KPL. OHNE MOTOR Loco chassis complete w/o motor	40706403	040
6	FAHRGESTELL M.LOK.-ZÄHNRÄDER Chassis with gearwheels	41706403	030
7	DECKPLATTE UNTEN Lower cover plate	00437063	005
8	LUFTKESSEL -SATZ Air tank (tender) set	00447063	009
9	VOR-U.NACHLAUFGESTELL Set of carrying wheels complete	00477063	016
10	ZYLINDERKASTEN KPL. MIT LICHTL Cylinder box complete w. light conductor	00487064	016
11	RADSATZ VOR-U.NACHLAUFGESTELL Carrying wheelset complete	00537030	011
12	STROMABNEHMEREINSATZ MIT LAMPE Power pick-up assembly comp. w. lamp	00607063	025
13	ENTSTÖRDROSSEL Suppressor choke	00644101	007
14	SCHRAUBE Screw	00700203	001
15	SCHRAUBE Screw	00702903	001
16	SENKSCHRAUBE Countersunk screw	00702910	001
Digital			
17	LOKGEHÄUSE KPL. Body assembly complete	10706483	034
18	LOKFAHRGESTELL KPL. OHNE MOTOR Loco chassis complete w/o motor	40706483	040
19	STROMABNEHMEREINSATZ MIT LAMPE Power pick-up assembly comp. w. lamp	06070631	018
20	DEKODER Decoder	68706482	032

Änderungen in Konstruktion und Ausführung vorbehalten
We reserve the right to change the construction and specification

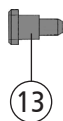
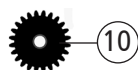
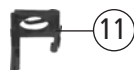
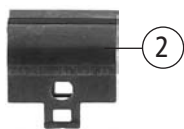
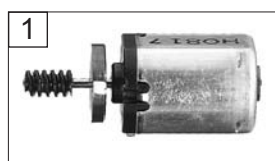
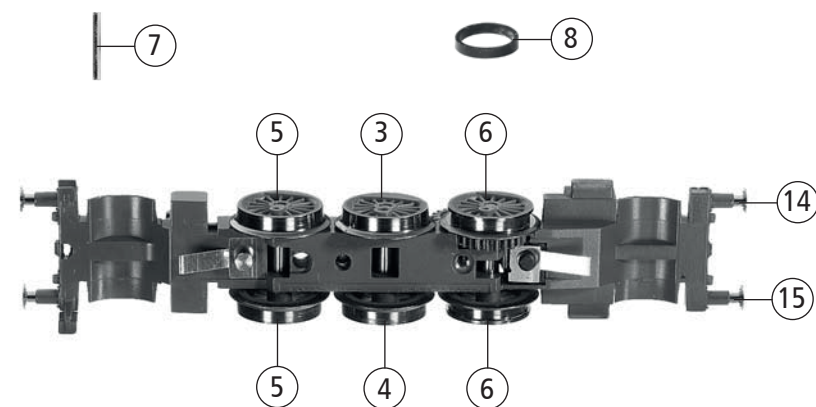

706403		DB	BR 064	=		N
706483				=		N
Pos. Nr. Pos.no.	Beschreibung Description	Art.-Nr. Art.no.	Preisgruppe Price bracket			
1	MOTOR KPL. Motor complete	50706101	030			
2	MOTORHALTEBÜGEL Motor retainer clip	00507906	002			
3	TREIBRAD LI. UGR. Left driving wheel	00517079	007			
4	TREIBRAD RE. UGR. Right driving wheel	00517080	007			
5	KUPPELRAD O.N. Left coupled wheel w/o groove	00517081	007			
6	KUPPELRAD M.NUT Left coupled wheel with groove	00517082	007			
7	Achse Axle	00527007	001			
8	HAFTREIFEN Traction tyre	00547004	001			
9	UNTERSETZUNGSRAD Reduction gear wheel	00567151	006			
10	ZAHNRAD Gear wheel	00567152	006			
11	LAMPENHALTER MIT BELEUCHTUNGSF. Lamp support with light contact spring	00637098	009			
12	BOLZEN F.KUPPELSTANGE Bolt for coupling rod	00730562	002			
13	BUNDBOLZEN FÜR ZAHNRAD Flanged bolt for gear wheel	00730564	002			
14	STECKPUFFER (GEWÖLBT) Plug-in buffer, curved	00757011	002			
15	STECKPUFFER (FLACH) Plug-in buffer, flat	00757012	002			
16	ERS.-GLUEHLAMPE KLAR M.STECKFA Replacem. bulb,clear, w. plug-in socket	00006535	008			
17	STANDARD-STECKKUPPLUNG Clip-in coupling	9525	---			
18	PROFI-STECKKUPPLUNG Profi Clip-in coupling	9545	---			